

SIVACON Low Voltage Switchboard

SIEMENS

Industrial Solutions and Services

Your Success is Our Goal

Versatile with Safety



Type tested Components for Power Distribution

The SIVACON® low voltage switchgear board is the standard solution for building and industrial technology.

SIVACON® is tailored to the needs of the world market, i.e. it takes into account the call for standard solutions from a single source on the one hand and on the other hand for local production and the resulting advantages in term of financing and procurement close to plant.

As a power distribution board, SIVACON® is available throughout the world and can be used in all power levels up to 7400 A, as withdrawable as well as plug in and fix mounted units.

Modular Technology

Every SIVACON® is made exclusively from standardized and type-coded modules. All modules are of high quality and conform to Siemens design specifications.

The multiple possibilities of combining the components fulfill every requirement.

The exclusive use of high-quality Siemens switchgear ensures a long service endurance and reliable operation.

Introduction

contents

04/20	SIVACON® Features
05/20	Always Flexible – SIVACON® Adapts to your Requirements
06/20	SIVACON for All Applications in the Low Voltage Network
07/20	SIVACON® - Frame and Enclosure
08/20	Variable Busbar System – The Answer to Device Requirements
09/20	Circuit-Breaker Design – Compact Reliable and User Friendly
11/20	Fixed-Mounted Design - Economical, Reliable and Variable
13/20	Reactive Power Compensation – Lower Costs with Increased Safety
14/20	Line Plug-in Design 3NJ6 – Plugged-in Swiftly, Always Safe
15/20	SIVACON - Low voltage switchboards Withdrawable unit design
16/20	Cubicle for Customized Solutions – Plenty of Space for Flexibility
17/20	Type-Tested Switchgear and Control gear Assembly (TTA) – Signed, Sealed and Delivered Safety
18/20	Technical Data – At a Glance
19/20	SIVACON 8PT for Ship Applications

SIVACON® Features

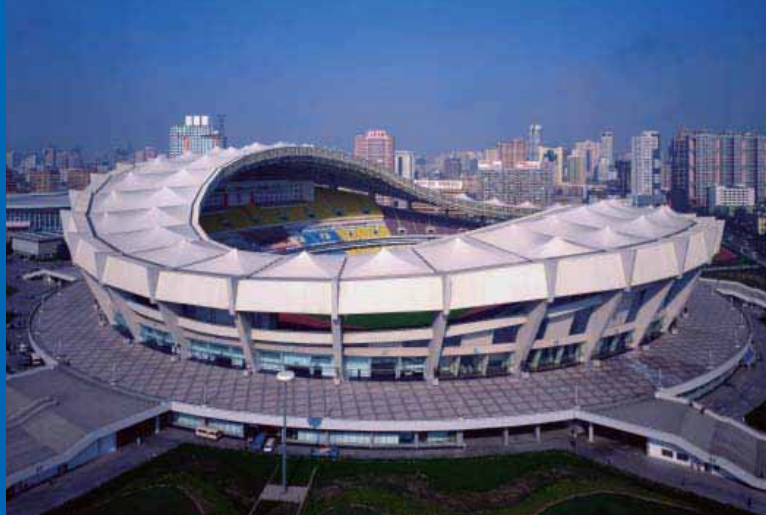

SIVACON Marine2

SIVACON® Features

- Type tested standard modules (TTA)
- Standardized busbar position at the top of the cubicle
- 3- and 4-pole busbar system up to 7400 A
- Rated peak withstand current I_{pk} up to 375 kA
- Deep switchgear compartment for universal installation
- Modular structure of device compartments
- Single-front and back-to-back installation
- Cable lead-in above and below
- Cable connection from the front and rear



SIVACON PT Industry

Always Flexible – SIVACON® Adapts to your Requirements



Modular technology makes it possible to adapt SIVACON® optimally to all requirements.

- Standard horizon busbar position at the top of the cubicle.
- Any components can be installed in the device compartments regardless of the busbar position and cubicle depth.
- Requirement-oriented compartmentalization of functional units (Form 1 to Form 4 according to IEC 60439-1)
- Deep device compartments

Optimum Adaptation to Space Conditions

- Wall-mounted or free standing
- Cable and busbar may be connected from above and below
- Cabling compartments front- or rear-located
- Good accessibility of busbar

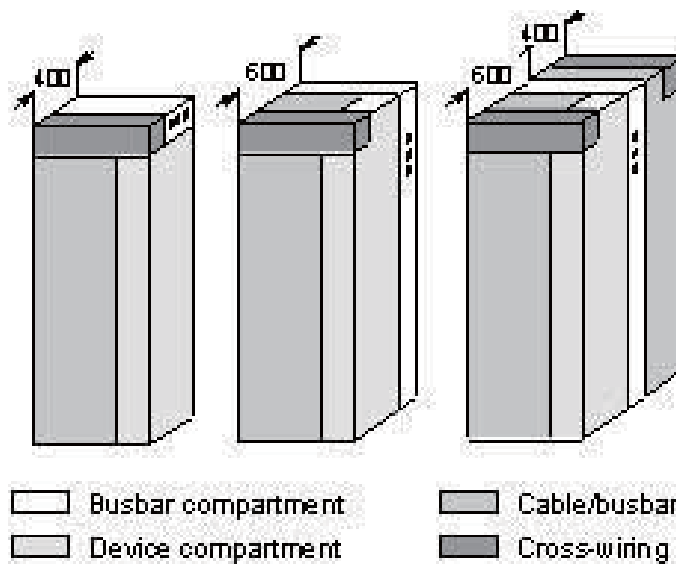

Graphic Structure Sivacon

SIVACON for All Applications in the Low Voltage Network

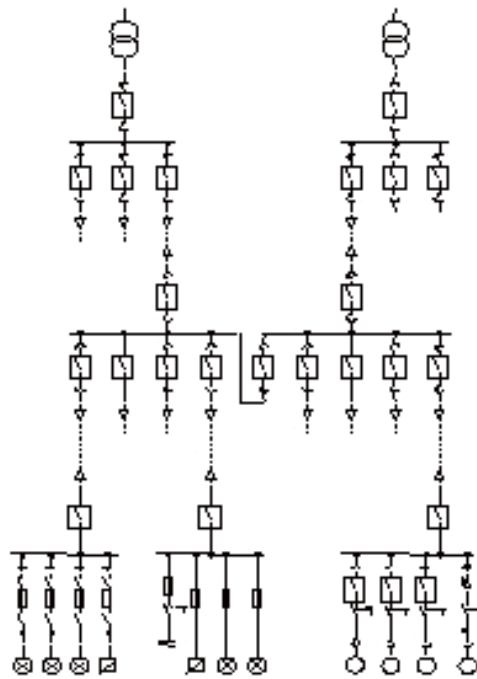

SWITCHGEAR Board
Please Rebuilt Graphic for Print

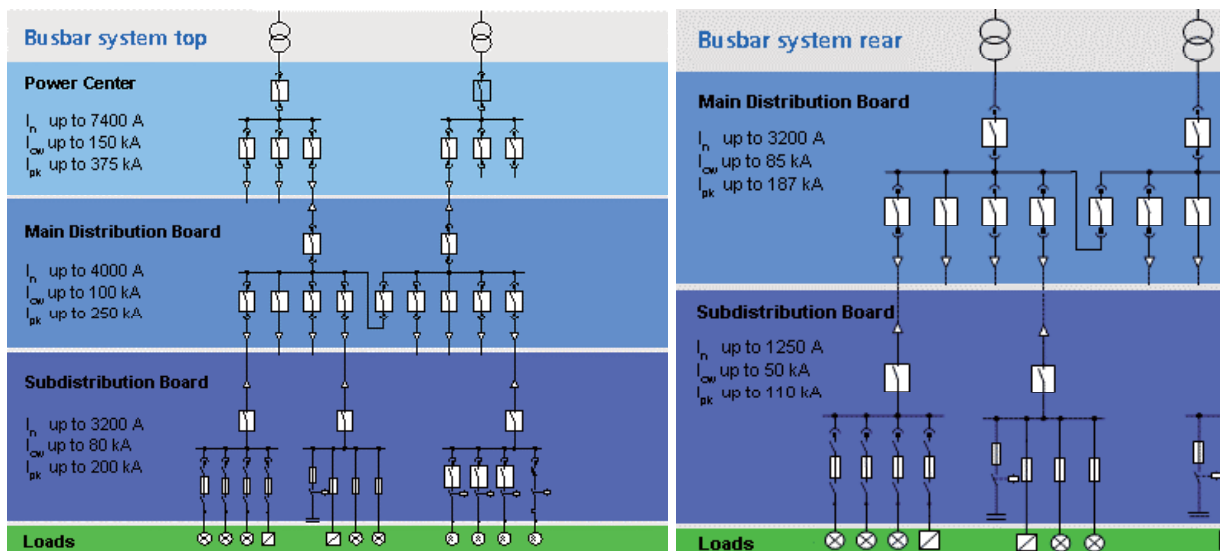

SIVACON® - Frame and Enclosure



Dimensionally Accurate and Stable

The frame consists of rigid sheet steel sections that are linked to one another:

SIVACON's® dimensionally accurate and sturdy frame is available in bolted or welded versions.

- All-round perforation rows with a 25-mm hole grid for individual installation.
- Flexible door system for all requirements
- Door opening angle up to 180
- Spring-loaded locks reliability prevent doors from opening unintentionally
- Pressure-relief top covers.

Surface Treatment

Optionally powder-coated, wet painted or sendzimir-galvanized

Material

Frame and enclosure are manufactured from sheet steel in the following thickness:
 Frame: 2,5 mm
 Enclosure: 2,0 mm

Degree of Protection to IEC 60529

IP 30, IP 31, IP 40, IP 41, IP 42,
 Naturally ventilated
 IP 40, IP 54 unventilated



Frame and Enclosure 2



Frame and Enclosure

Frame Top

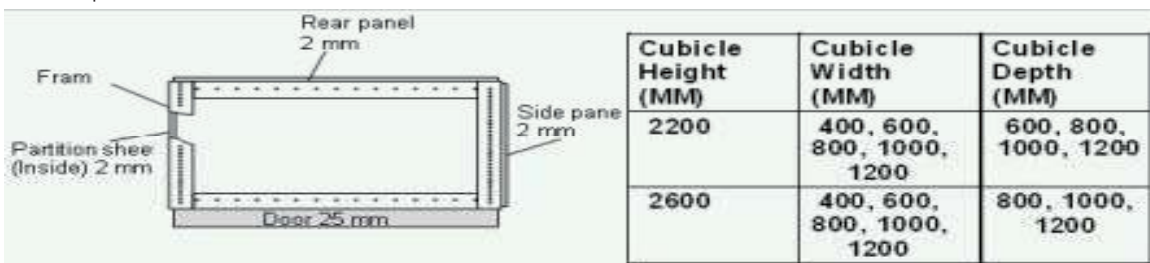

Variable Busbar System – The Answer to Device Requirements



Differing Requirements for the busbar call for individual options.

SIVACON® offers modules for economical setup and high level of safety

- Busbar positions on top
- Busbar system for rated currents up to 7400 A
- User-oriented gradation of rated currents
- Rated peak withstand current 1pk to 375kA
- Separation of busbar compartment from device compartment
- Transport unit joints easily accessible from above
- Arc barrier for limiting the effects of the arcing fault



Busbar System 1

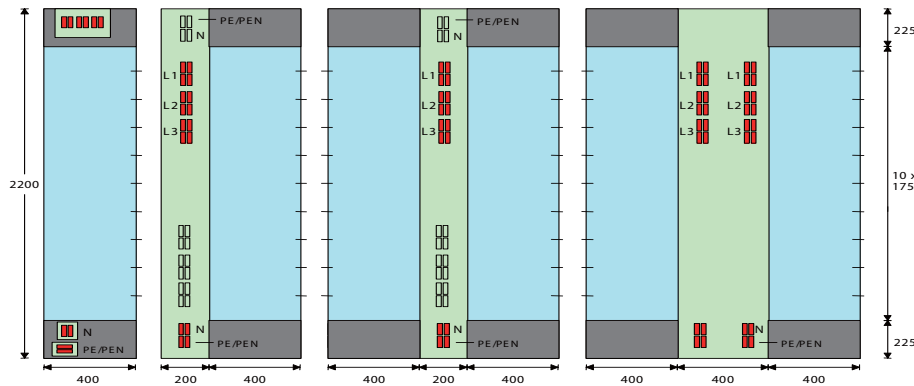

Busbar System 2

up to 3200 A

up to 4000 A

up to 7400 A

Rated currents at 35 °C ambient temperature

Phase conductors (L1, L2, L3) Quantity, dimensions [mm]	unventi- lated [A]	venti- lated [A]	I_{pk} / I_{low} [kA]	Cubicle height [mm]	Cubicle depth [mm]
2 x 100 x 10	2400	3200	200/80	2200	600, 800, 1000
3 x 100 x 10	2950	4000	250/100	2200	800, 1000, 1200
3 x 100 x 10 + 3 x 100 x 10	5400	7400	375/150	2600	800, 1000, 1200

Busbar System 3

Circuit-Breaker Design – Compact Reliable and User Friendly



The supply, feeder and coupling cubicles of the circuit-breaker design are equipped with withdrawable or fixed-mounted 3W. Circuit-breaker (ACB).

As a large number of loads are generally connected to these cubicles, particular importance is attached to them in terms of the long-term operating reliability and personal safety of the switchboard.

SIVACON® meets these requirements with circuit-breaker design components.

Compact and Reliable

- High degree of safety due to type-tested standard modules (TTA)
- Test and disconnected positions with door closed
- Circuit-breaker integrated in separate compartments, each equipped with separate doors
- Optimum connection conditions for every rated current range
- Cable connections from above or below

User Friendly with 3W

Siemens 3W. fixed-mounted and withdrawable circuit breakers are used for the rated current range from 630 A to 6300 A.

This means:

- Free choice of the supply direction without any restriction in term of technical data
- High short-time current-carrying capacity for time-graded short circuit protection up to 400 ms assures reliable operation of sections of the switchboard not affected by short circuit.
- Short-circuit protection with short-time grading control (ZSS) for every brief delay times (50ms), irrespective of the grading level
- LCD operating current indication in the control console (without ammeters and current transformers)
- Indication and operation when the door is closed



Circuit Breaker Design Picture



Circuit Breaker Cabinet 2

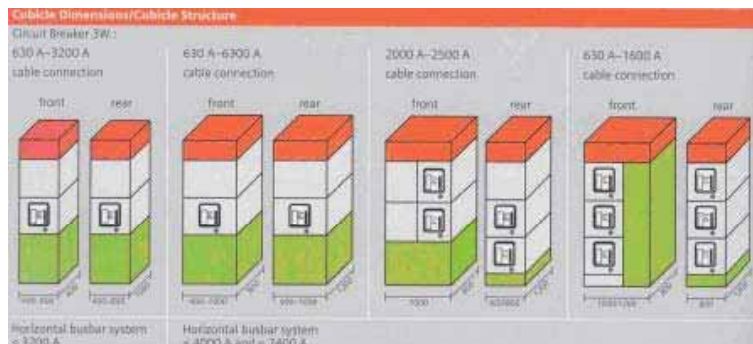

Circuit Breaker Cabinet 3

Circuit-Breaker Design – Compact Reliable and User Friendly

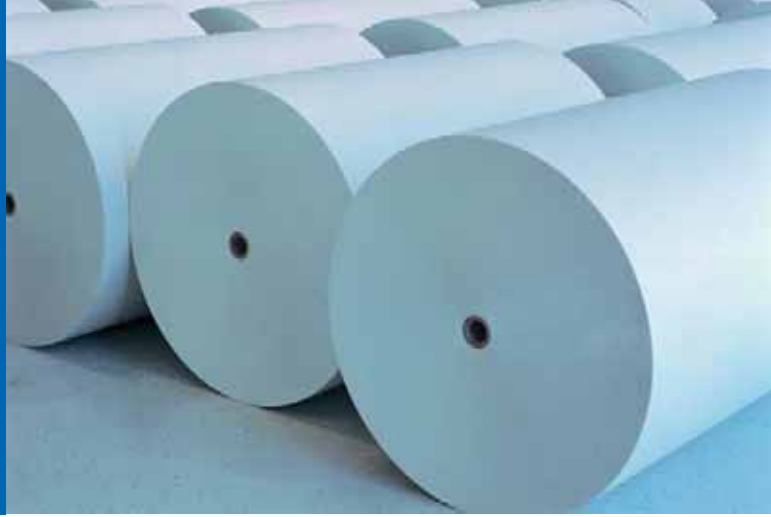

Switching Device Compartment

- Reliable travel of circuit breaker while door is closed
- A maintenance position allows direct local inspection without removal of the circuit breaker

Cable Busbar Connection Compartment

- Cable of busbar connection optionally from above or below
- A rated current-dependent connection compartment offers optimum termination conditions for cable and busbar
- Assembly times are shortened by optimum connection compartments



Circuit Breaker Maintain Position



CIRCUIT Breaker DOOR Closed PIX



Circuit Breaker Cabinet 6

Fixed-Mounted Design - Economical, Reliable and Variable



The cubicles for cable feeders in fixed mounted execution are equipped with molded-case circuit breakers or fuse-switch disconnectors (conventional or in-line), depending on requirements.

These cubicles are used for applications in which replacement under operating conditions is not necessary or where short downtimes are acceptable.

In this case, the SIVACON® fixed mounted design offers excellent.

Modular Cable Feeders

The modular cable feeders enable efficient installation, above all whenever operation-specific changes or adaptations are necessary:

Molded-case circuit breakers or fuse-switch disconnectors can be fitted as required

- Free combination of cable feeders within one cubicle
- Continuously adjustable mounting plates for a standard front plane
- Cable feeders with and without current measurement

High degree of safety due to type- tested standard modules (TTA)

- Any combination of modular cable feeders
- Swift conversion due to lateral universal distribution busbar
- Easy replacement of cable feeders after deenergizing the switchboard



Circuit Breaker fixed mounted cabinet



Circuit Breaker 2

Fixed-Mounted Design - Economical, Reliable and Variable



Switchable In-Line Fuse-Switch disconnectors

The in-line fuse-switch disconnectors make for optimum packing density thanks to their compact design and their modular structure.

- Motor and cable feeder up to 630 A
- Modular mounting plates in a 60 mm system
- MCCB circuit-breaker as incomer up to 1250 A
- Capacitor modules up to 100 kvar
- Fuse-switches, in-line type up to 630 A, fixed-mounted
- Lighting distribution with NEOZED fuses, type N-mcb etc.

Modular mounting plates

- Free choice of combination of components or assemblies
- Freedom of combination of equipped modular plates within the cubicle
- Variable modular sizes from 1 to 5 M
- Fixing system for "one man assembly"

Internal separation

- Horizontal separation of compartments
- Cubicle-high or individual doors
- Separation from cable connection compartment

Fuse-switches, in-line type, fixed

- Feeder circuits up to 630 A
- Packing density up to 16 units per cubicle
- Volt-free fuse changing
- Freedom of combination within the cubicle



Picture SIVACON Fix mounted Cabinet



Pix of fixed mounting plate



Pix of fixed mounted design



Pix of fixed mounted design 2

Reactive Power Compensation – Lower Costs with Increased Safety

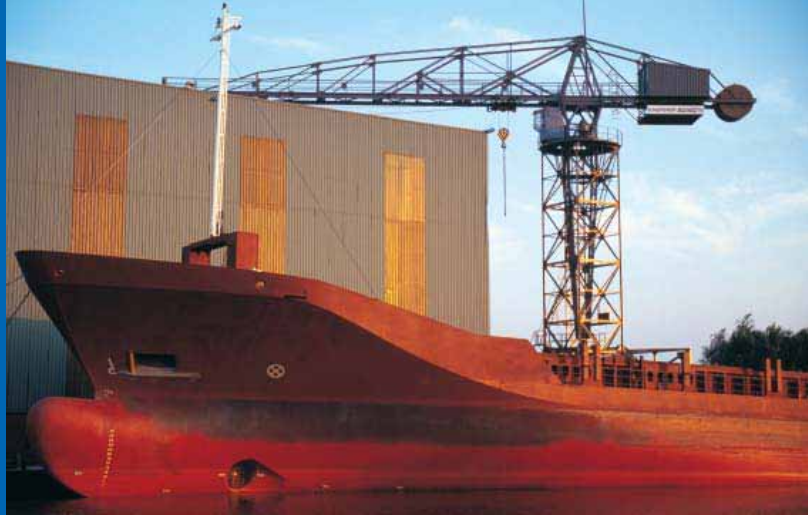

The cubicles for central reactive power compensation ease the load on transformers and cables, reduce transmission losses and save current costs. Depending on the load structure, they are equipped with choke- less or choked capacitor modules.

Controller Module with Electronic Power Factor Controller for Flush

- Door Mounting
- Multifunction display
- Self-adaption of the C/k value
- Adjustable nominal $\cos \phi$ from 0.8 ind to 0.98 cap
- Manual/automatic operation

Capacitor Module up to 100 kvar

- Fuse-switch disconnectors
- Capacitor contactors
- MKK power capacitors
- Discharging units
- Filter circuit chokes



Picture SIVACON Reactive Power Compensation

Line Plug-in Design 3NJ6 – Plugged-in Swiftly, Always Safe

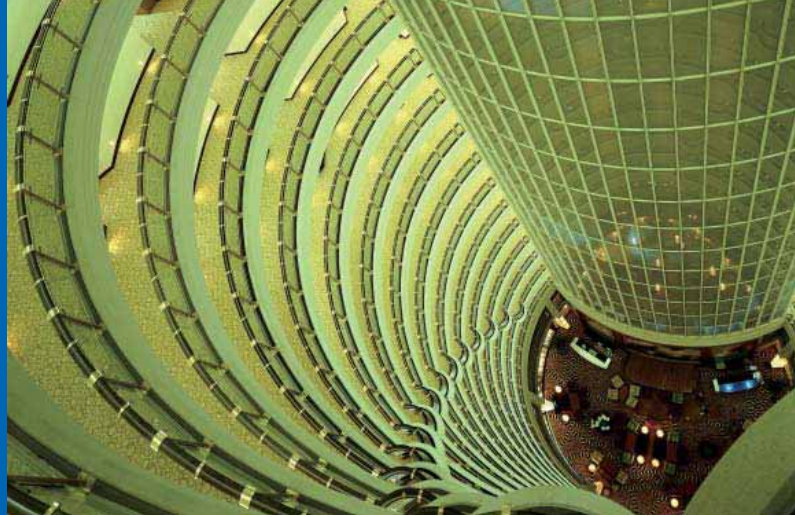

The in-line plug-in design outgoing feeders represent a low-priced alternative to the withdrawable-unit design. By virtue of the supply-side plug-in contact and their compact design, the modules provide the facility for easy and quick interchangeability without switchboard shutdown.

With the in-line plug-in design, SIVACON® offers good cost effectiveness, safety and flexibility.

- High level of safety by virtue of type-tested standard modules (TTA)
- Supply-side plug-in contacts enable quick replacement
- In-line type switching devices for cable feeders up to 630 A available in the following designs:
 - Fuse module with fuses
 - Fuse-switch disconnectors (single-break)
 - Fuse-switch disconnectors (double-break)
 - Switch disconnectors
- High packing density (up to 34 feeders per cubicle)
- Dead-state fuse replacement
- Protection against electric shock from plug-on bus system
- 400 and 600 mm wide cable connection compartment
- Degree of protection up to IP 40
- Possibility of replacing a feeder without having to shut down the system



Picture Plug-in design Cabinet 1

Pix plug-in module 1 and 2

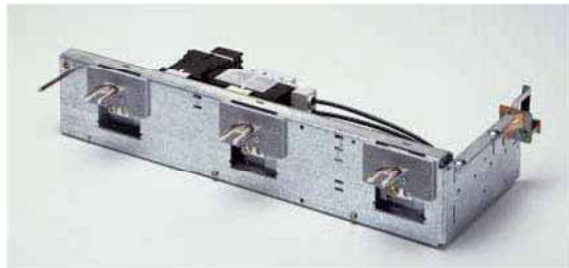
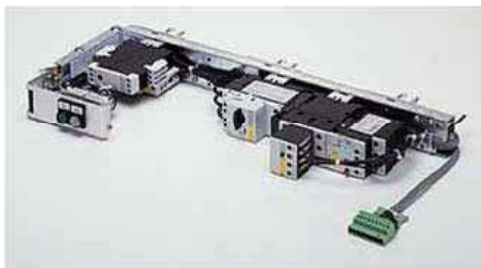

SIVACON - Low voltage switchboards

Withdrawable unit design



Motor and cable feeders up to 630 A and Highest packing density with 40 withdrawable units per cubicle. The cabinet can be run on Test and disconnected position with door closed.

Visible isolating gaps on incoming and outgoing side, Standard operator interface for all withdrawable units and 400 mm large cable connection compartment are some things about many that make this design so flexible to customers needs.

- Fault arc proof encapsulation
- Safe-to-touch protection (IP20B)
- Phase separation
- 3 and 4 pole
- Tape-off points at modular 175 mm distance
- Rated peak withstand current (I_{pk}) up to 143 kA
- Rated current up to 1000 A

The Plug-in Bus system

The conversion of compartments is possible without board shutdown.

The withdrawable units:

Only six withdrawnable sizes:

Size 1/4, 1/2 = 1 module (11/18,5 kW, 20-pole auxiliary contact)

Size 1, 2, 3, 4 = 1 M to 4 M (37/75/200/250 kW, 40-pole auxiliary contact)

All parts are located within the contours of a withdrawnable unit and give protection against damage. Easy insertion without exceeding reasonable forces make the switch of units simple and plenty of space at the rear of the cabinet for auxiliary devices and swing-out instrument plates allows adjustment during operation.

Separate actuation of main switch and withdrawnable unit make the operating system safe and error protected.



withdrawable 1



Plug-in bus system



withdrawable module 1, 2, + withdrawable cabinet empty

Cubicle for Customized Solutions – Plenty of Space for Flexibility



Various installation components are available for customized solutions, e.g. for open and closed-loop control tasks.

- 3- and 4-pole vertical distribution busbars
- Rated currents up to 1200 A
- Rated short-time withstand current up to I_{cw} 65 kA
- Cubicle-length doors or compartment doors
- Compartmentalization
- Various installation components



Plug-in design Cabinet 1

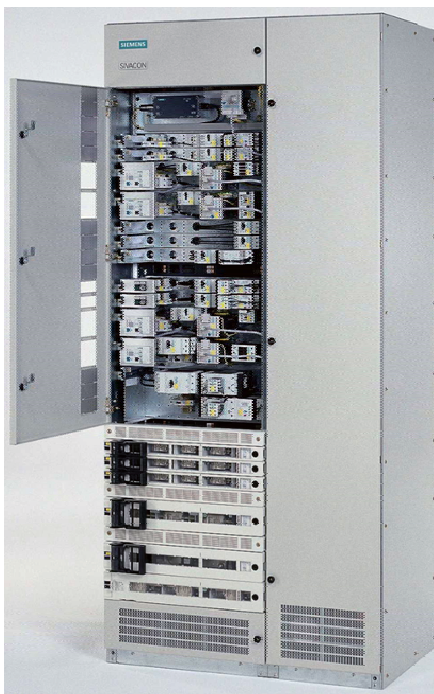

Plug in design Cabinet 2

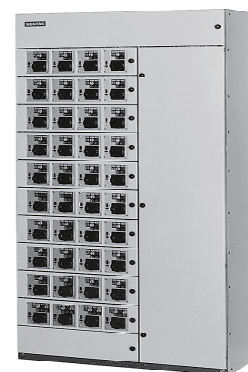

Cabinet Withdrawable

Type-Tested Switchgear and Control gear Assembly (TTA) – Signed, Sealed and Delivered Safety



SIVACON® is a type-tested switchgear and control gear assembly (TTA) whose physical characteristics were designed in the test laboratory both for normal operating conditions and for fault situations. Conclusive type tests assure a maximum of reliability and personal safety.

SIVACON® has passed the following verification tests as detailed in IEC 60439-1, DIN EN 60439-1 (VDE 0660 Part 500):

Type Testing

- Verification of temperature rise limits by test
- Verification of dielectric properties by test
- Verification of the short-circuit withstand strength by test
- Verification of the effective connection between the exposed conductive parts of the assembly and the protective circuit by inspection or resistance measurement
- Verification of the short-circuit with- stand strength of the protective circuit by test
- Verification of clearances and creep age distances
- Verification of mechanical operation
- Verification of the degree of protection

Every SIVACON® Switchboard Undergoes Routine Testing Before Delivery:

- Inspection of the assembly including wiring and, if necessary, electrical operation test.
- Dielectric test
- Checking of protective measures and of the electrical continuity of the protective circuits

These Safety Requirements are supported by a Series of Details in SIVACON® for Example:

- With the withdrawable circuit- breaker design, operating errors are ruled out by exactly shaped mechanical guides and interlocks
- Only a few, exclusively high-quality insulating materials are used (e.g. for busbar supports, reinforcements, etc)
- Use of high-quality Siemens switch- gear ensures long lifetime and mini- mized downtimes
- Reliable disconnection after 70 to 100 ms, even at long-time delays by 3WN circuit breakers with short-time grading control (ZSS)
- Computer-assisted configuring ensures error-free selection and arrangement of items
- Arcing fault-tested
- Effective quality management

Technical Data – At a Glance



Standards and Specifications	Type-tested low-voltage switchgear and control assembly (TTA) Testing of response to internal faults 2	IEC 60439-1, DIN EN 60439-1 (VDE 0660 Part 500) IEC 61641, VDE 0660 Part 500, Supplement	
Creepage distances and clearance	Rated impulse withstand voltage (U _{imp})	8kv	
	Overvoltage category	III	
	Pollution Degree	3	
Rated isolation voltage (U _i)		1000 V	
Rated operation voltage (U _e)		Up to 690 V	
Rated currents (I _n) Busbar (3-pole and 4-pole)	Main horizontal busbar	Rated current Rated	up to 7400A
		Peak withstand current (I _p)	up to 375kA
		Rated short-term withstand current (i _{cw})	up to 150kA 1s up to 120
	Vertical busbar for circuit breaker	Rated current	Ka, 3s Up to 6300A
		Peak withstand current (I _p)	Up to 250 kA
		Rated short-term withstand current (i _{cw})	Up to 100 kA
	Vertical Busbar for fixed-mounted design	Rated current	1S up to 80 kA, 3S Up to 1400A
		Peak withstand current (I _p)	Up to 163 kA
		Rated short-term withstand current (i _{cw})	Up to 65 kA * . 1s
	Vertical busbar for in-line plug-in design (3NJ6)	Rated current	Up to 50 kA, 3s Up to 2100 A
		Peak withstand current (I _p)	Up to 110 kA
		Circuit breakers	Up to 6300 A
		Outgoing Feeders	Up to 6300 A
Internal separation	From 1 to 4	IEC 60439-1, Section 7.7, DIN EN 60439-1	
Surface treatment	Frame parts	Galvanized/powder-coated/wet-paint	
	Enclosure	Galvanized/powder-coated/wet-paint	
	Doors	Galvanized/powder-coated/wet-paint	
Degree protection	To IEC 60439-1, EN 60529	IP 30 to IP 54	
Dimensions		Height	2200, 2600 mm (with busbar top unit)
		Width	400, 600, 800, 1000, 1200 mm
		Depth	600, 800, 1000, 1200mm

Rated conditional short-circuit current I_{cc} up to 100 kA

SIVACON 8PT for Ship Applications

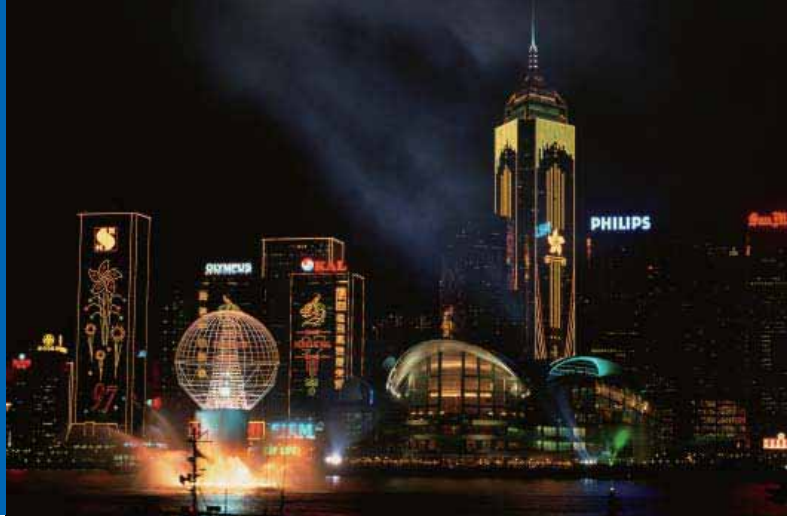

Whether in regions that are prone to earthquakes or under the toughest conditions on the seven seas – you are always on the safe side with our SIVACON 8PT. This is because it has stood up to all of the relevant earthquake tests and has the Type Approval Certificate for use on ships and offshore equipment. Type-tested standard modules ensure the highest degree of safety and cost-effectiveness. Waves and high vibration levels caused by engines on ships or drilling rigs in continuous high levels cause a lot of stress to the cabinet.

A challenge that SIVACON 8PT masters supremely – and it has all of the certificates to prove
For the SIVACON 8PT for Ship Applications the following options exist differing from the standard:

- A switchboard with two busbar systems lying one behind another for rated currents from 4000A up to 7000A and a switchboard depth of 1200mm.
- Switchboard construction in "back to back" installation for the busbar system 3200A and a switchboard depth of 2x600mm.
- FCB1 cubicles with cable connection at rear for a busbar system of 4000A and a switchboard depth of 800mm.

Additional Modules complete the portfolio of the Switchgear system to the special requirements of marine applications:

Modules "Door stop"

The modules "door stop" are integrated depending on the hinge type and design type of the cabinet and detain free-fall door movements.

Modules "Handrail"

The modules "hand rail" allow a secured access to take good hold during the working processes.

Modules "Lighting"

To keep a good overview, the switchboard can be equipped with a lighting top front on the cubicle. The minimal cubicle height is 600mm. The lighting is possible on every second cubicle.



Picture SIVACON Marine